

SCOREBOARDS



SKOU R.	4	1	1	5	8	48	5	6	1	4	OH Y.
MIKKELSEN	5	3	3	1	1	5	WOO S.	1	5	WOO S.	
VESTERGART	6	4	4	2	2	6	HUG S.	2	2	6	HUG S.
JDERGENSEN	7	2	16	102	2	87	LEE G.	1	7	LEE G.	
THOMSEN C.	8	7	7	HOME	VISITOR	8	JANG S.	8	8	JANG S.	
MORTENSEN	9	2	30	24	4:25	62	1:34	13	9	KIM H.	
MIREAKOU	10	2	2	32	3:16	12	4:43	2	10	KIM C.	
JENSEN T.	11	3	3	38	1	11	OH S.	38	1	OH S.	
FRUPELLINO	12	1	1	12	MOON K.	12	MOON K.	12	12	MOON K.	
SCHINDT	13	1	1	26	2	13	LIM O.	26	2	13	LIM O.
ANDERSEN	14	1	1	14	LEE S.	14	LEE S.	14	14	LEE S.	
BROEDSGART	15	29	29	2	15	YOUNG B.	2	15	15	YOUNG B.	



SATURN

2.900 series

Installation manual / Manuel d'installation / Bedienungsanleitung



INTERNATIONAL
ICE HOCKEY
FEDERATION

3500.501

Version 1.5



Caution and safety precautions

- Never use any other charger than the supplied or a type approved by Swiss Timing. This could destroy the battery, cause damage to unit, and possible cause personal injury due to fire or/and electrical shock.
- Never bypass a power cord ground lead by breaking off the ground pin, or by using inappropriate extension cords or adapters.
- Never plug a power cord into the AC power source until you have made sure that all installation, cabling and power levels, are proper, and that the applicable procedures in this manual have been followed.
- Protect the equipment against splashing, rain and excessive sun rays.
- Never use the device if it is damaged or insecure.
- Verify the selection of the power distribution.
- Verify that the voltage quoted on the rating plate is the same as your voltage. Connect the appliance only to power sockets with protective earth. The use of incorrect connection voids warranty.
- This program may be modified at any time without prior notification.
- Do not open the case; there is nothing that needs servicing inside it. Nevertheless, if the case must be opened, you must call for some qualified personnel. The power supply cable must be disconnected before opening the case.
- During the transport of all Swiss Timing equipment delivered with a reusable carry case, the said case should be used at all times. This is imperative to limit the damage, such as shocks or vibration that can be caused to the units during transport.
- The same cases should also be used when returning equipment to Swiss Timing for repair. Swiss Timing reserves the right to refuse all guarantees if this condition is not fulfilled.
- If the installation includes a horn, be sure to maintain a sufficient security distance from the public.

Documentation Updates

Swiss Timing Ltd. reserves the right to make improvements in the products described in this documentation at any time without prior notice. Furthermore, Swiss Timing Ltd. reserves the right to revise this documentation in its content at any time and without any obligation to notify any person or organization of such revision.

Disclaimer

The information provided in this documentation has been obtained from sources believed to be reliable, accurate and current. However, Swiss Timing Ltd. makes no representation or warranty, express or implied, with respect, but not limited to, the completeness, accuracy, correctness and actuality of the content of this documentation. Swiss Timing Ltd. specifically disclaims any implied warranty of merchantability, quality and/or fitness for any particular purpose. Swiss Timing Ltd. shall not be liable for errors contained in this documentation or for incidental or consequential damages in connection with the supply, performance or use of this documentation.

Environment



This symbol indicates that this product should not be disposed with household waste. It has to be returned to a local authorized collection system. By following this procedure you will contribute to the protection of the environment and human health. The recycling of the materials will help to conserve natural resources.

Copyright

© Swiss Timing Ltd.

All rights reserved.

This documentation may not, as a whole or in part, be copied, translated, reproduced, transmitted or reduced and/or stored to any electronic medium or machine-readable form without the prior written consent of Swiss Timing Ltd.

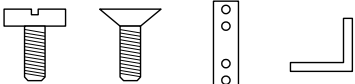

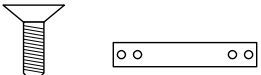

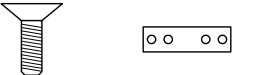



TABLE OF CONTENTS

1	MECHANICAL PARTS / PIÈCES MÉCANIQUES / MECHANISCHES ZUBEHÖR	1
1.1	Installation material / Matériel d'installation / Installationsmaterial	1
1.2	Fixing parts / Pièces de fixation / Fixierplatten.....	2
1.3	Cable crossing / Passage des câbles / Kabelführung.....	3
1.4	Fixing examples / Variantes de fixation / Befestigungsvarianten	4
2	MECHANICAL INSTALLATION / INSTALLATION MÉCANIQUE / MECHANISCHE INSTALLATION	5
2.1	Scoreboard dimensions / Dimensions tableaux / Tafelanzeigegröße	5
2.1.1	Main scoreboard / Tableau principal / Hauptanzeigetafel	5
2.1.2	Penalties / Pénalités / Strafen	6
2.1.3	Personal faults / Fautes personnelles / Persönliche Fehler	7
2.1.4	Player names / Noms joueurs / Spielernamen.....	8
2.1.5	Team names / Noms des équipes / Mannschaftsname	8
2.1.6	General overview / Vue générale / Allgemeine Uebersicht	9
2.2	Assembly / Montage / Montage	10
2.2.1	Model 2.901	10
2.2.2	Model 2.901 + 2.951 Team names / Noms des équipes / Mannschaftsname	10
2.2.3	Model 2.912	11
2.2.4	Model 2.912 + 2.951 Team names / Noms des équipes / Mannschaftsname	12
2.2.5	Model 2.922 (+ 2.951)	13
2.2.6	Model 2.923 (+ 2.951)	14
2.2.7	Model 2.932 (+ 2.951)	15
2.2.8	Model 2.933 (+ 2.951)	16
2.2.9	Model 2.932 (+ 2.951) + 2.952	17
2.2.10	Model 2.933 (+ 2.951) + 2.952	18
2.3	Basketball accessories / Accessoires basketball / Zubehör Basketball	19
2.3.1	Shot clock 1/10 with game time (1 face) 2.993.12	19
2.3.2	Shot clock 1/10 with game time (2 faces) 2.993.22	19
2.3.3	Shot clock - floor standing / - montage au sol / - Montage am Boden	20
2.3.4	Shot clock - stanchion mounting / - montage sur panier / - Korbbefestigung	20
2.3.5	Possession 2.984.....	21
2.3.6	Total faults per team 2.985.....	21
2.4	Backstop panel / Panneau backstop / Anzeige Backstop	22
2.4.1	Specifications / Spécifications / Spezifikationen	22
2.4.2	Assembly / Montage / Montage	23
2.4.3	Mounting material / Matériel de montage / Befestigungsmaterial.....	23
2.5	Goal lamp and interface IHO / Lampe de but et interface IHO / Torlampe und Interface IHo	24

2.5.1	Dimensions / Dimensions / Grösse.....	24
2.5.2	Mounting / Montage / Montage.....	25
2.5.3	Accessory 3500.014 / Accessoire 3500.014 / Zubehör 3500.014.....	25
2.6	External horn / Klaxon externe / Externe Hupe.....	26
2.7	Saturn LCD Controller / Console LCD Saturn / Bedienungspult LCD Saturn.....	26
3	ELECTRICAL INSTALLATION / INSTALLATION ELECTRIQUE / ELEKTRISCHE INSTALLATION.....	27
3.1	Main scoreboard / Tableau principal / Hauptanzeigetafel.....	27
3.1.1	Cabling / Câblage / Kabel.....	27
3.1.2	Switches setting / Sélection des switches/ Schalter und Einstellungen.....	30
3.1.3	Brightness setting / Sélection luminosité / Wahl der Helligkeit.....	30
3.2	Shot clock / Shot clock / Shot clock.....	31
3.2.1	Single face / Simple face / Einseitig.....	31
3.3	Possession 2.984.....	32
3.4	Total faults per team 2.985.....	32
3.5	Backstop panel / Panneau Backstop / Anzeige Backstop.....	33
3.6	Goal lamps / Lampes de but / Torlampen.....	34
3.7	External horn / Klaxon externe / Externe Hupe.....	35
3.8	Controller / Console / Bedienungspult.....	35
4	APPENDIX.....	36
4.1	Version history.....	36

1 MECHANICAL PARTS / PIÈCES MÉCANIQUES / MECHANISCHES ZUBEHÖR

1.1 Installation material / Matériel d'installation / Installationsmaterial

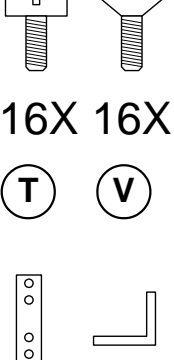
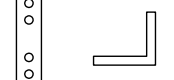
 3500.701 2300 x 1050mm	 8X 8X 4X 4X (T) (V) (A) (C)
 3500.600 2300 x 200mm  3500.740 2300 x 200mm	 8X 2X (V) (B)
 3500.711 2300 x 525mm  3500.712 2300 x 1050mm	 8X 2X (V) (A)
 3500.721 2x 555 x 2300mm  3500.722 2x 865 x 2300mm  3500.731 2x 1350 x 2300mm	 16X 16X (T) (V)  8X 8X (A) (C)

1.2 Fixing parts / Pièces de fixation / Fixierplatten

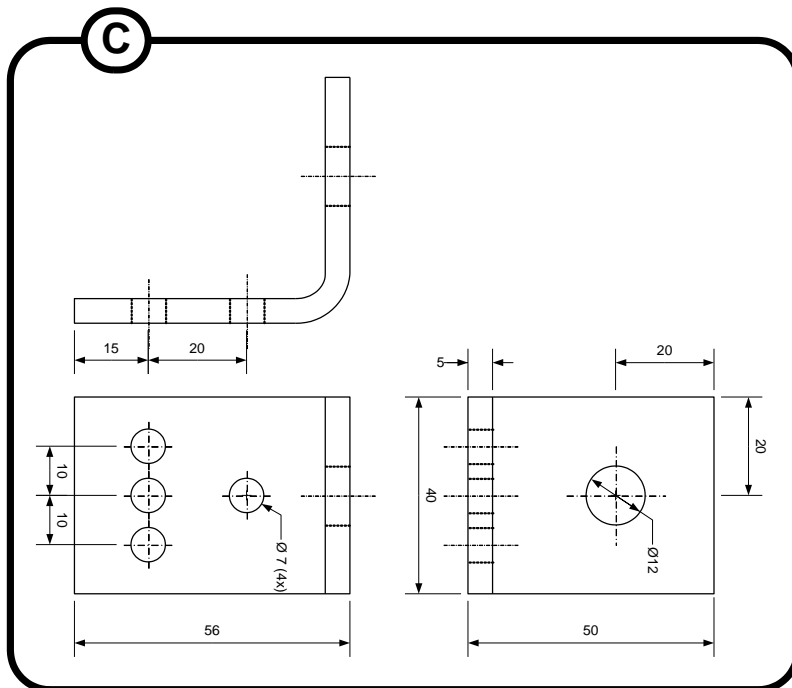
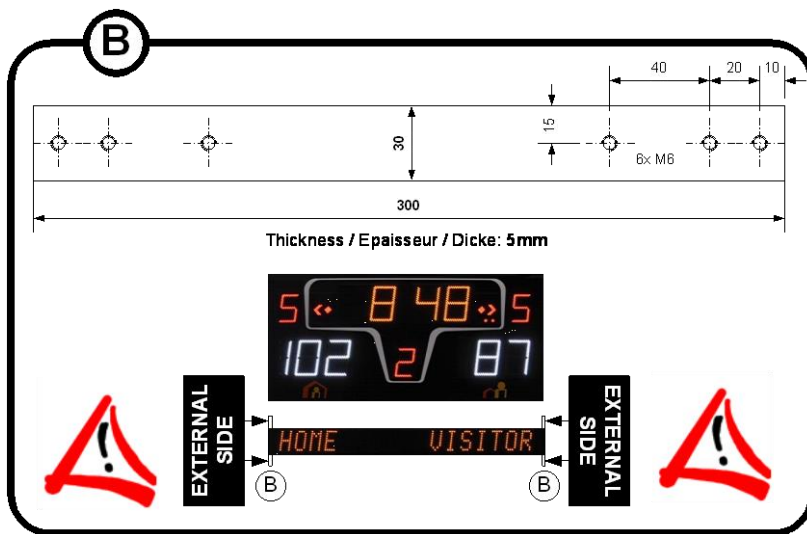
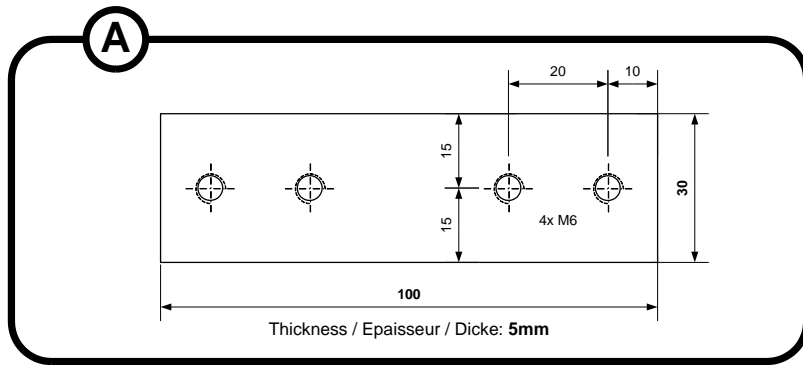

1.3 Cable crossing / Passage des câbles / Kabelführung



Prepare cable crossing before mounting.
Préparer les passages de câbles avant le montage.
Kabelpassagen vor der Montage vorbereiten.



Warning ! / Attention ! / Achtung !

To connect the modules
Pour connecter les modules
Um die Module zu verbinden

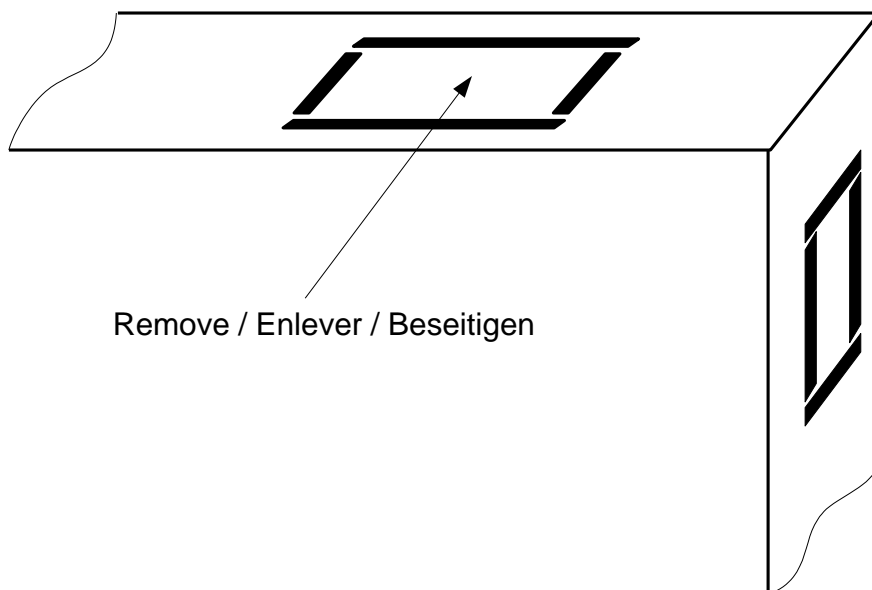

Remove / Enlever / Beseitigen

1.4 Fixing examples / Variantes de fixation / Befestigungsvarianten

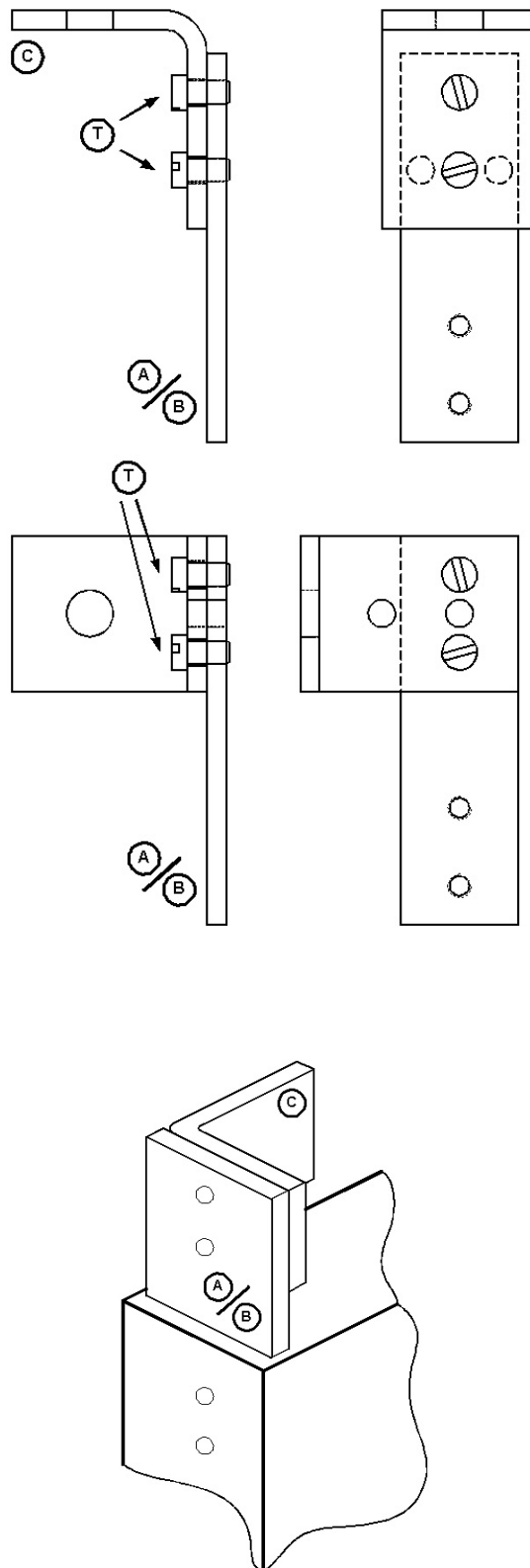

2 MECHANICAL INSTALLATION / INSTALLATION MÉCANIQUE / MECHANISCHE INSTALLATION

2.1 Scoreboard dimensions / Dimensions tableaux / Tafelanzeigegröße

2.1.1 Main scoreboard / Tableau principal / Hauptanzeigetafel



3500.701

Dimensions / Dimensions / Grösse (mm):

2300 x 1050 x 85

Weight / Poids / Gewicht (kg):

56

Power / Puissance / Strom (VA):

300

2.1.2 Penalties / Pénalités / Strafen



3500.711

Dimensions / Dimensions / Grösse (mm):	2300 x 525 x 85
Weight / Poids / Gewicht (kg):	29
Power / Puissance / Strom (VA):	150



3500.712

Dimensions / Dimensions / Grösse (mm):	2300 x 1050 x 85
Weight / Poids / Gewicht (kg):	56
Power / Puissance / Strom (VA):	300



3500.601

Dimensions / Dimensions / Grösse (mm):	2300 x 525 x 85
Weight / Poids / Gewicht (kg):	17

2.1.3 Personal faults / Fautes personnelles / Persönliche Fehler



Left / Gauche / Links



Right / Droite / Rechts

3500.721

Dimensions / Dimensions / Grösse (mm):
 Weight / Poids / Gewicht (kg):
 Power / Puissance / Strom (VA):

2x 555 x 2300 x 85
2x 32
2x 150



Left / Gauche / Links



Right / Droite / Rechts

3500.722

Dimensions / Dimensions / Grösse (mm):
 Weight / Poids / Gewicht (kg):
 Power / Puissance / Strom (VA):

2x 865 x 2300 x 85
2x 47
2x 200

2.1.4 Player names / Noms joueurs / Spielernamen



Left / Gauche / Links



Right / Droite / Rechts

3500.731

Dimensions / Dimensions / Grösse (mm):

2x 1350 x 2300 x 85

Weight / Poids / Gewicht (kg):

2x 77

Power / Puissance / Strom (VA):

2x 600

2.1.5 Team names / Noms des équipes / Mannschaftsname



3500.740

Dimensions / Dimensions / Grösse (mm):

2300 x 200 x 85

Weight / Poids / Gewicht (kg):

15

Power / Puissance / Strom (VA):

300



3500.600

Dimensions / Dimensions / Grösse (mm):

2300 x 200 x 85

Weight / Poids / Gewicht (kg):

7

2.1.6 General overview / Vue générale / Allgemeine Uebersicht

Model	3500.								
	701	711	712	721	722	731	740	600	601
2.901									
2.901 + 2.951									
2.912									
2.912 + 2.951									
2.913									
2.913 + 2.951									
2.922									
2.922 + 2.951									
2.923									
2.923 + 2.951									
2.932									
2.932 + 2.951									
2.932+ 2.951+ 2.952									
2.933									
2.933 + 2.951									
2.933 + 2.951+ 2.952									

Included / Inclus / Inbegriffen

Model	Dimensions Dimensions Grösse	Weight Poids Gewicht	Power Puissance Strom
	A x B (mm)	(kg)	(VA)
2.901	2300 x 1050	56	300
2.901 + 2.951	2300 x 1250	71	600
2.912	2300 x 2100	112	600
2.912 + 2.951	2300 x 2300	127	900
2.913	2300 x 2625	141	750
2.913 + 2.951	2300 x 2825	156	1050
2.922	3410 x 2300	183	900
2.922 + 2.951		191	1200
2.923	3410 x 2825	212	1050
2.923 + 2.951		220	1350
2.932	4030 x 2300	206	1000
2.932 + 2.951		214	1300
2.932+ 2.951+ 2.952	6730 x 2300	358	1900
2.933	4030 x 2825	236	1150
2.933 + 2.951		244	1450
2.933 + 2.951+ 2.952		6730 x 2825	388



2.2 Assembly / Montage / Montage

2.2.1 Model 2.901

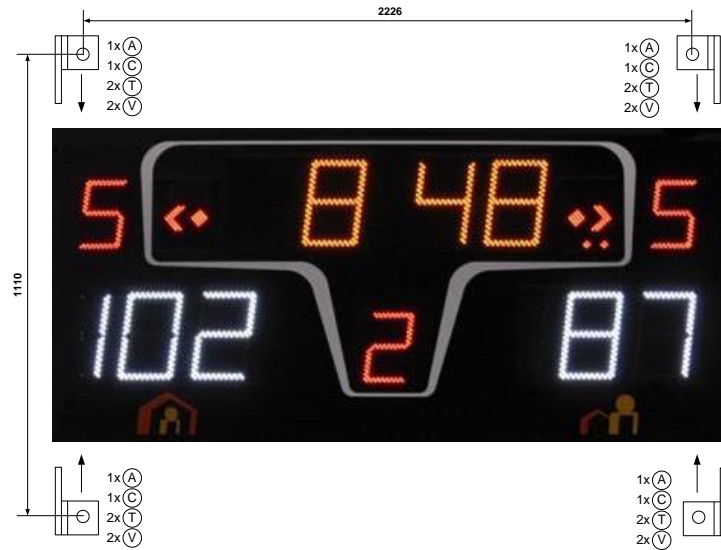

Dimensions / Dimensions / Grösse (mm):	2300 x 1050 x 85
Weight / Poids / Gewicht (kg):	56
Power / Puissance / Strom (VA):	300

2.2.2 Model 2.901 + 2.951 Team names / Noms des équipes / Mannschaftsname

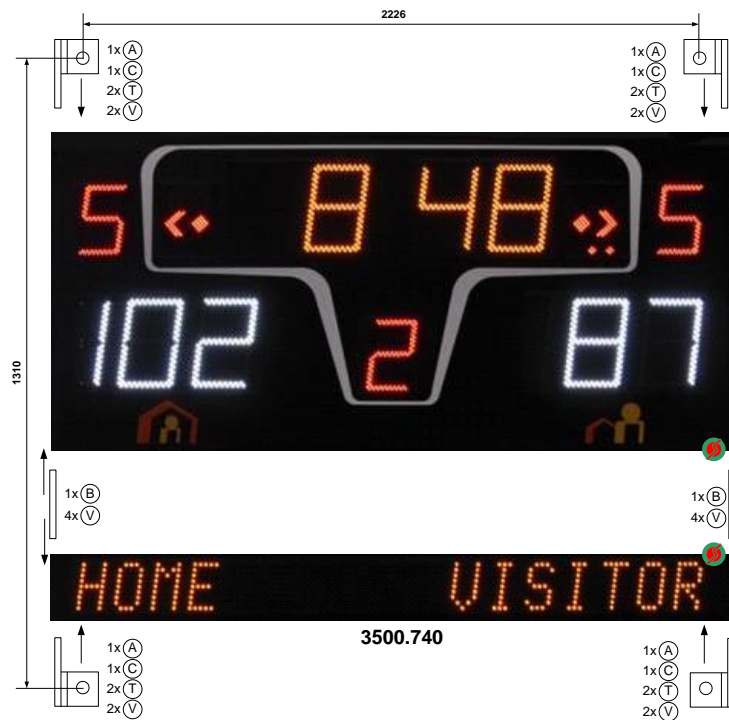

Dimensions / Dimensions / Grösse (mm):	2300 x 1250 x 85
Weight / Poids / Gewicht (kg):	71
Power / Puissance / Strom (VA):	600

2.2.3 Model 2.912

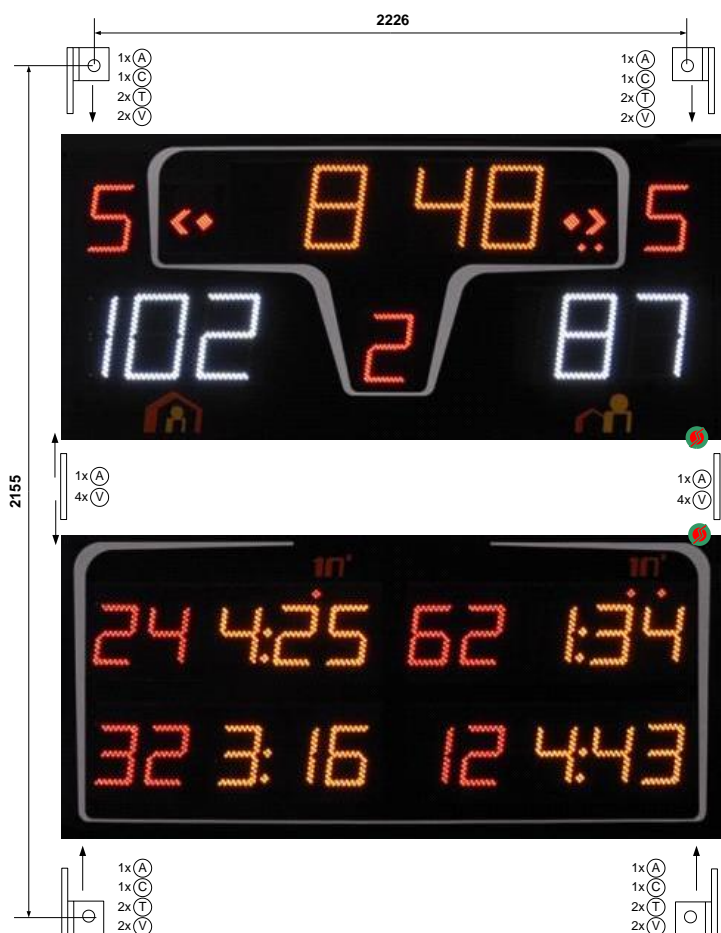

Dimensions / Dimensions / Grösse (mm):
 Weight / Poids / Gewicht (kg):
 Power / Puissance / Strom (VA):

2300 x 2100 x 85
 112
 600

2.2.4 Model 2.912 + 2.951 Team names / Noms des équipes / Mannschaftsname



Dimensions / Dimensions / Grösse (mm):

2300 x 2300 x 85

Weight / Poids / Gewicht (kg):

127

Power / Puissance / Strom (VA):

900

2.2.5 Model 2.922 (+ 2.951)

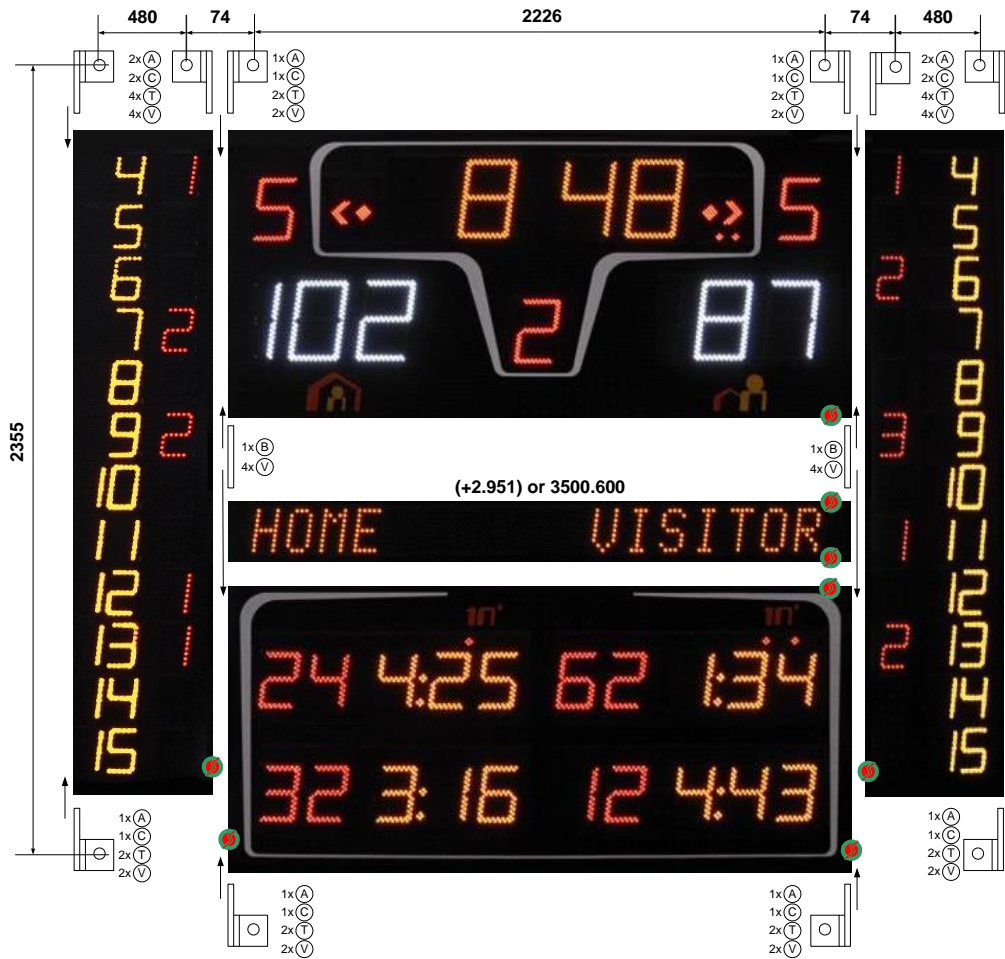

Dimensions / Dimensions / Grösse (mm):

Weight / Poids / Gewicht (kg):

Power / Puissance / Strom (VA):

3410 x 2300 x 85

183

191 HOME VISITOR

900

1200 HOME VISITOR

2.2.6 Model 2.923 (+ 2.951)

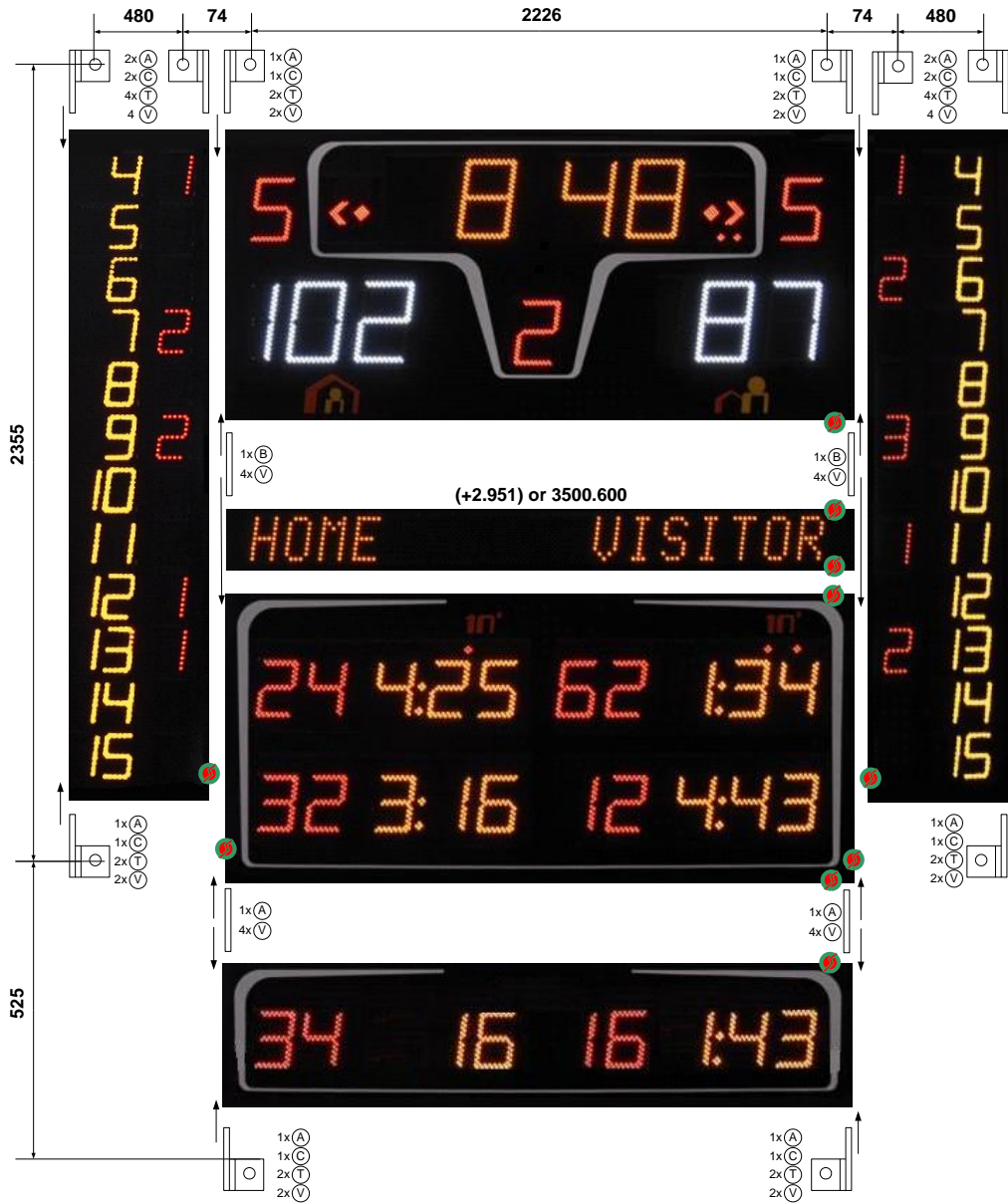

Dimensions / Dimensions / Grösse (mm):

Weight / Poids / Gewicht (kg):

Power / Puissance / Strom (VA):

3410 x 2825 x 85

212

220 HOME VISITOR

1050

1350 HOME VISITOR

2.2.7 Model 2.932 (+ 2.951)

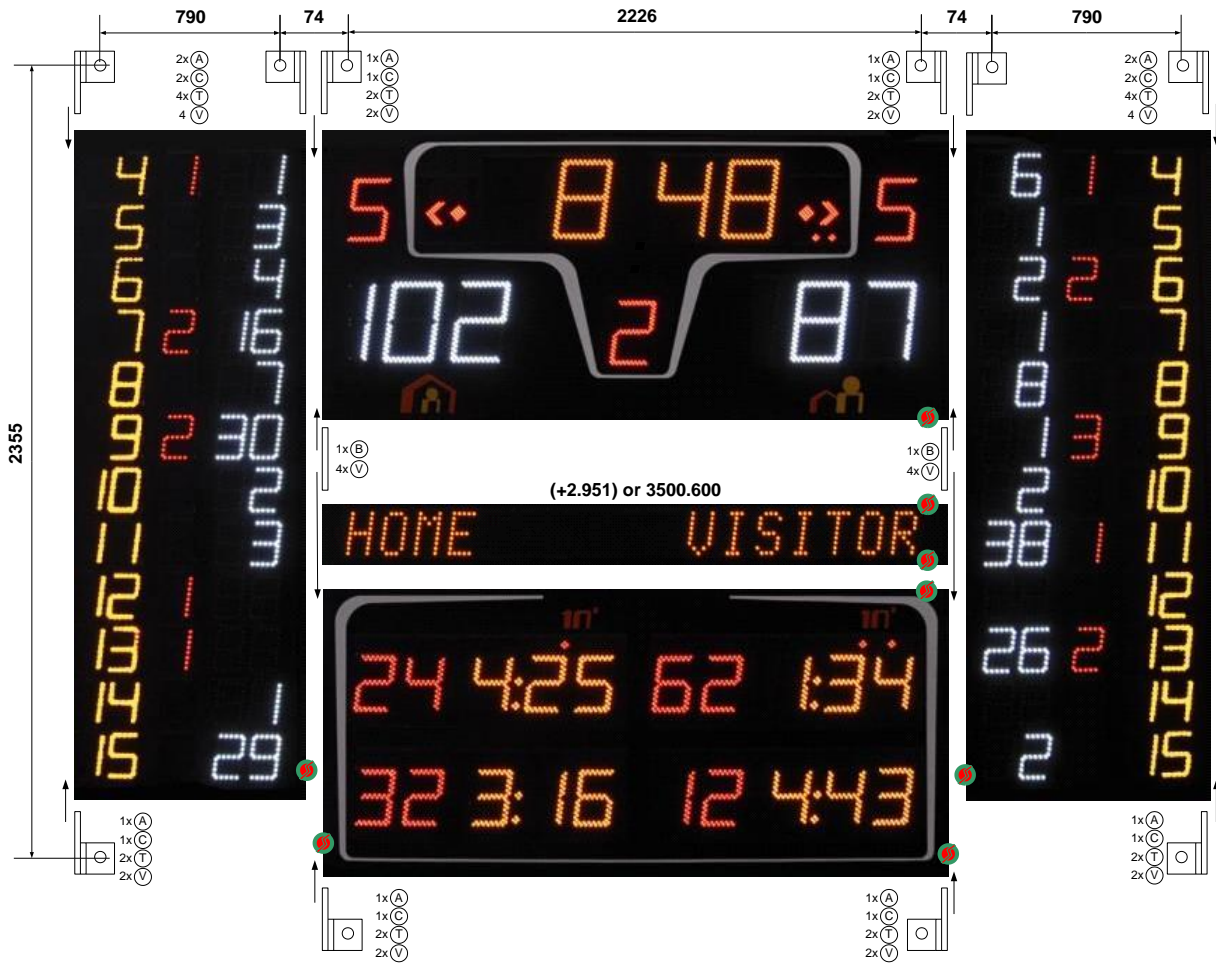

Dimensions / Dimensions / Grösse (mm):

Weight / Poids / Gewicht (kg):

Power / Puissance / Strom (VA):

4030 x 2300 x 85

206

214 HOME VISITOR

1000

1300 HOME VISITOR

2.2.8 Model 2.933 (+ 2.951)

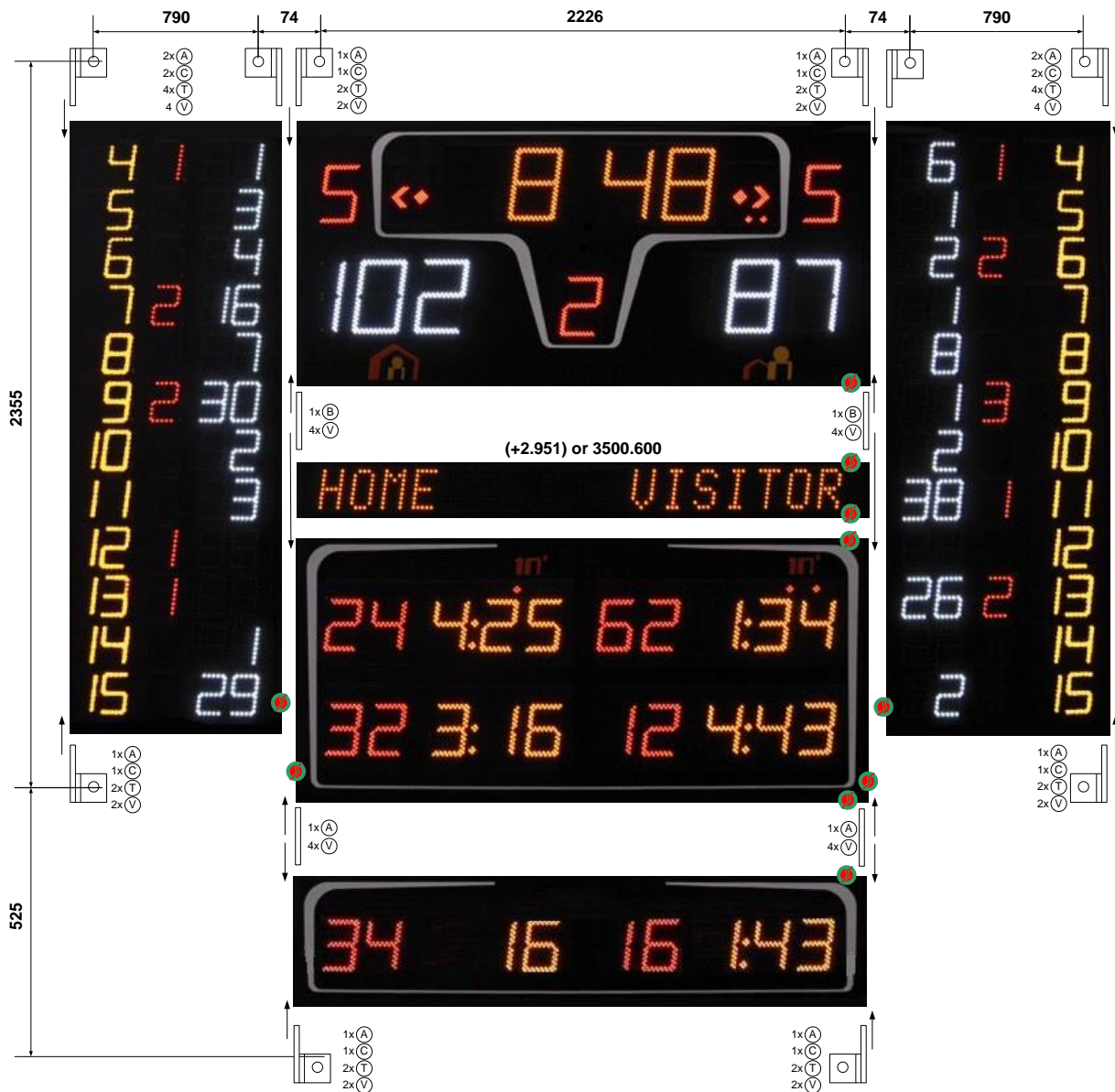

Dimensions / Dimensions / Grösse (mm):

Weight / Poids / Gewicht (kg):

Power / Puissance / Strom (VA):

4030 x 2825 x 85

236

244

1150

1450

HOME VISITOR

HOME VISITOR

2.2.9 Model 2.932 (+ 2.951) + 2.952

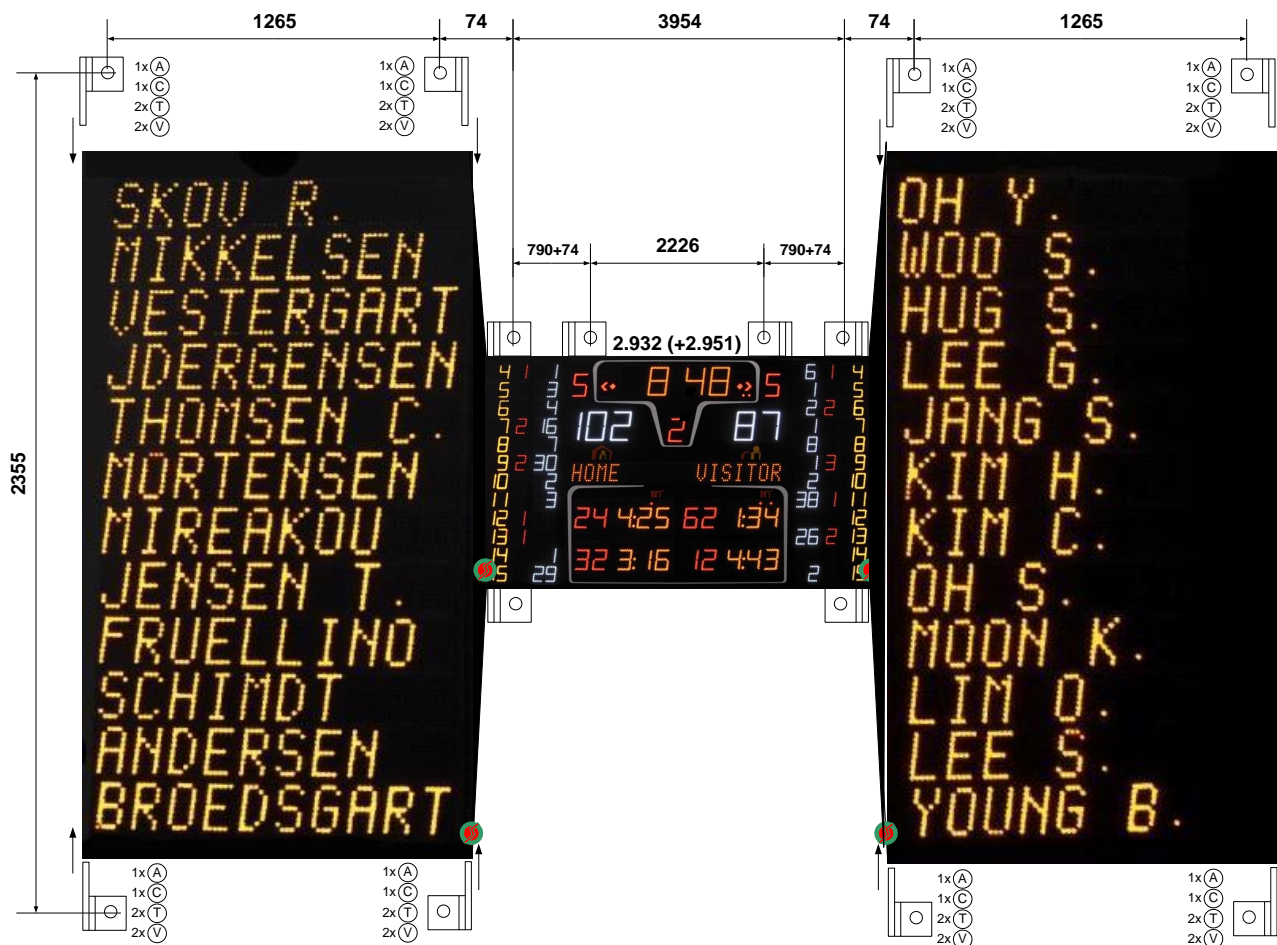

Dimensions / Dimensions / Grösse (mm):
 Weight / Poids / Gewicht (kg):
 Power / Puissance / Strom (VA):

6730 x 2300x 85
 251
 1900

2.2.10 Model 2.933 (+ 2.951) + 2.952

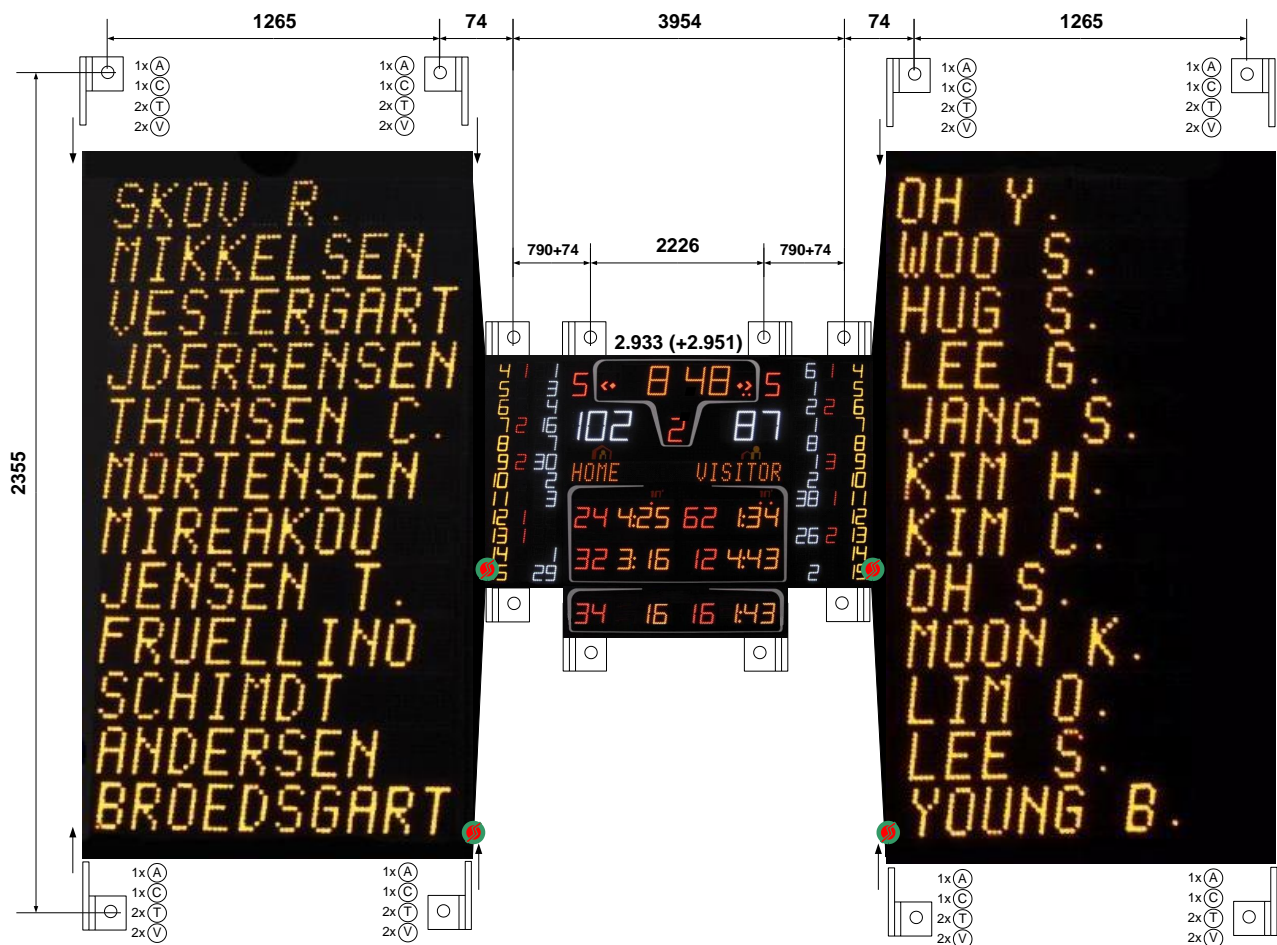

Dimensions / Dimensions / Grösse (mm):
 Weight / Poids / Gewicht (kg):
 Power / Puissance / Strom (VA):

6730 x 2825 x 85
 251
 2050

2.3 Basketball accessories / Accessoires basketball / Zubehör Basketball

2.3.1 Shot clock 1/10 with game time (1 face) 2.993.12



3500.791.01

Dimensions / Dimensions / Grösse (mm):	680 x 600 x 92
Weight / Poids / Gewicht (kg):	9
Power / Puissance / Strom (VA):	110

2.3.2 Shot clock 1/10 with game time (2 faces) 2.993.22



3500.791.02

Dimensions / Dimensions / Grösse (mm):	680 x 600 x 92
Weight / Poids / Gewicht (kg):	14
Power / Puissance / Strom (VA):	200

2.3.3 Shot clock floor standing / Montage au sol / Montage am Boden

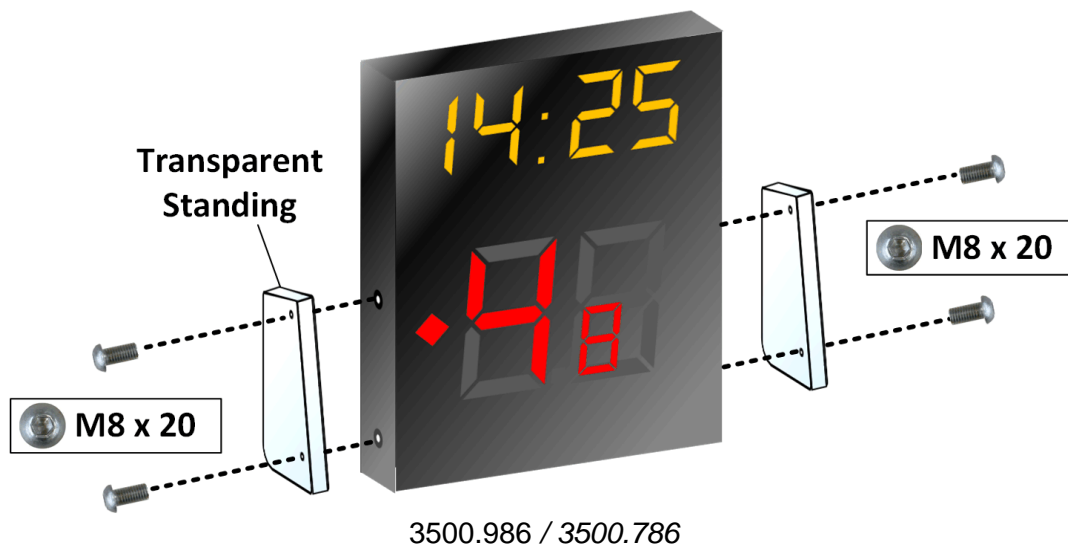

2.3.4 Shot clock stanchion mounting / Montage sur panier / Korbbelegung

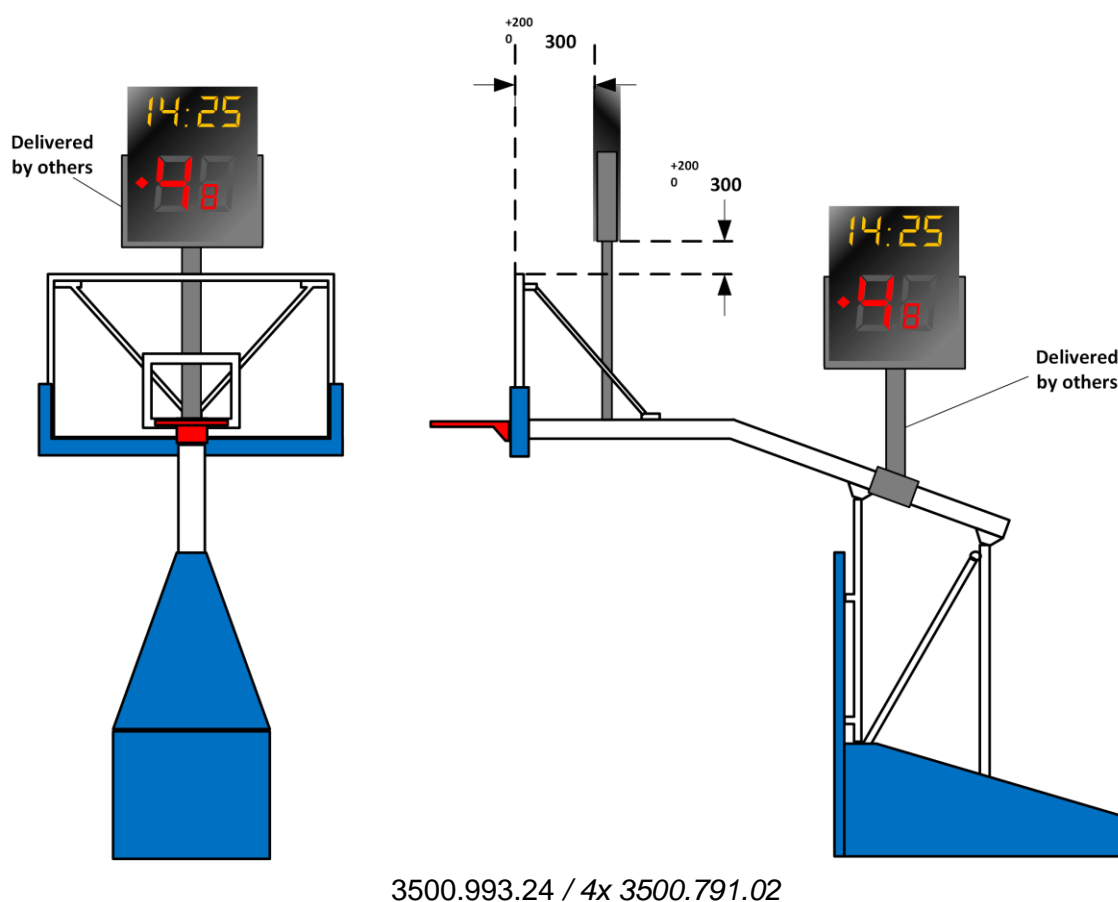

2.3.5 Possession 2.984



3500.784

Dimensions / Dimensions / Grösse (mm):

510 x 230 x 170

Weight / Poids / Gewicht (kg):

510 x 170 x 55 (Display/Affichage/Anzeige)

Power / Puissance / Strom (VA):

2

70

2.3.6 Total faults per team 2.985



3500.785

Dimensions / Dimensions / Grösse (mm):

280 x 445 x 245

Weight / Poids / Gewicht (kg):

5.4

Power / Puissance / Strom (VA):

500

2.4 Backstop panel / Panneau backstop / Anzeige Backstop

2.4.1 Specifications / Spécifications / Spezifikationen

3510.716 **-BBR1-**



3510.716 **-BBR2-**



3510.716 **-BBR3-**



3510.716 **-BBR4-**



3510.716 **-BBR5-**



3510.717 **-BBY1**



	Model	Dimensions Dimensions Grösse (mm)	Weight Poids Gewicht (kg)	Power Puissance Strom (VA)	Cable length Longueur câble Kabellänge (cm)
3510.716	BBR1	680 x 18 x 13	0.2	10	30
	BBR2	860 x 18 x 13	0.2	10	
	BBR3	1645 x 18 x 13	0.4	15	
	BBR4	860 x 18 x 13	0.2	10	
	BBR5	680 x 18 x 13	0.2	10	
3510.717	BBY1	1580 x 18 x 13	0.4	15	200

2.4.2 Assembly / Montage / Montage

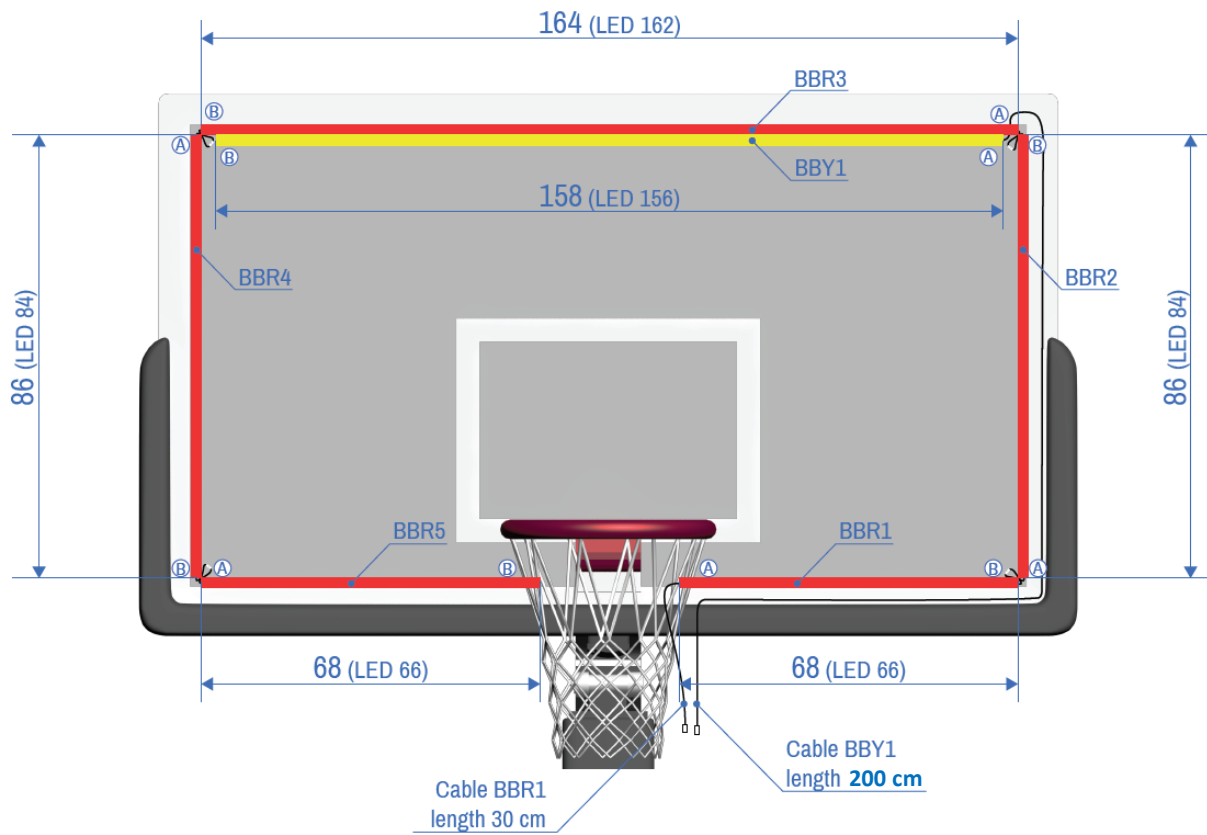

3510.935.01 / 3510.716 – 3510.717

2.4.3 Mounting material / Matériel de montage / Befestigungsmaterial

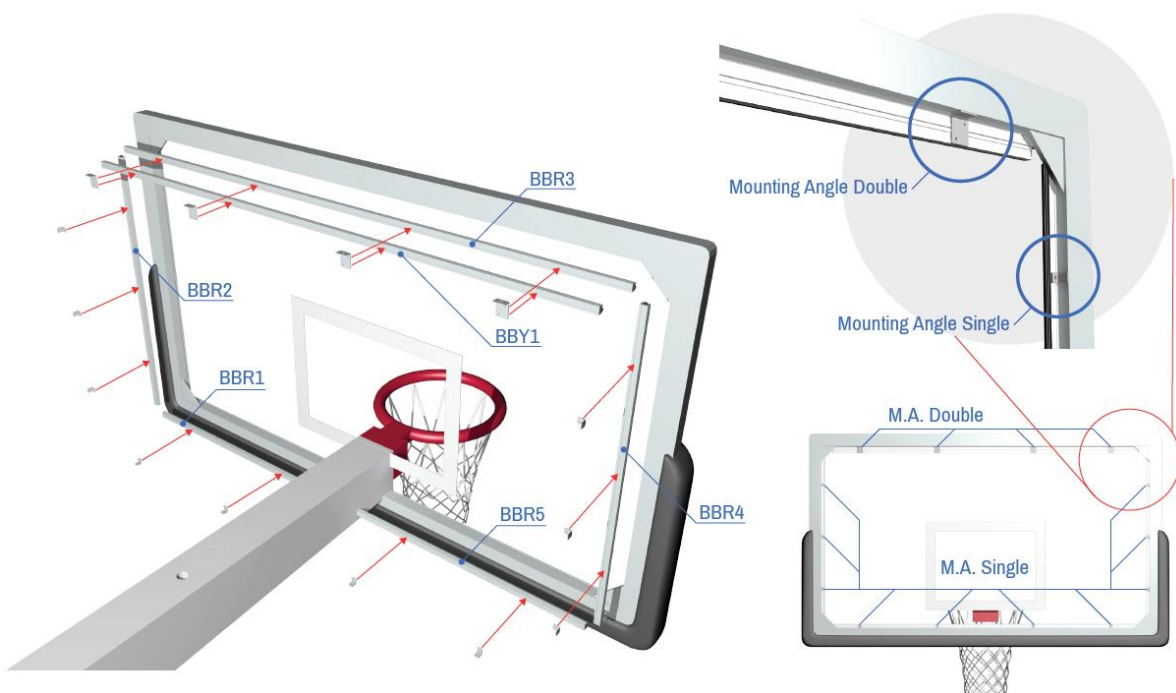

3510.935.01 / 3510.729

2.5 Goal lamp and interface IHO / Lampe de but et interface IHO / Torlampe und Interface IHo

2.5.1 Dimensions / Dimensions / Grösse

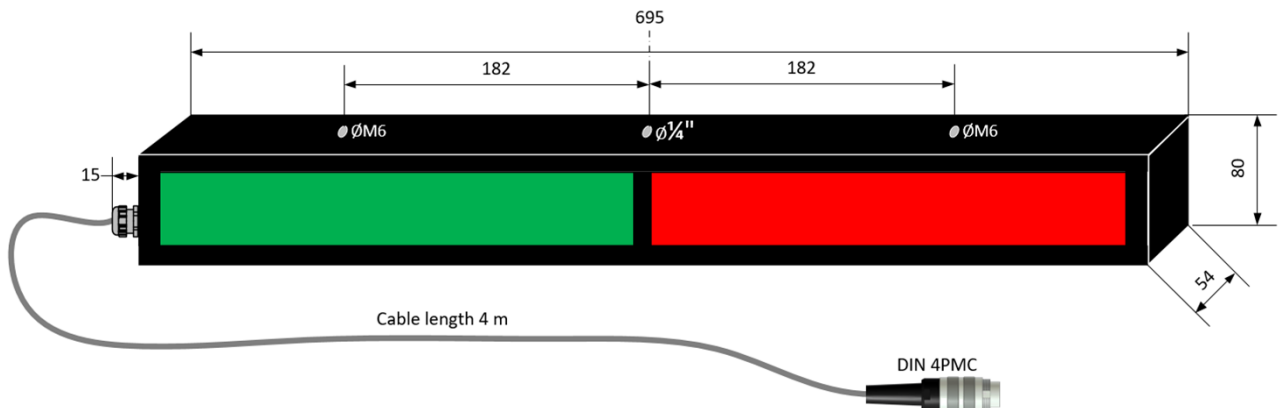

Dimensions / Dimensions / Grösse (mm):

695 x 55 x 80

Weight / Poids / Gewicht (kg):

1.5

Power / Puissance / Strom (VA):

24

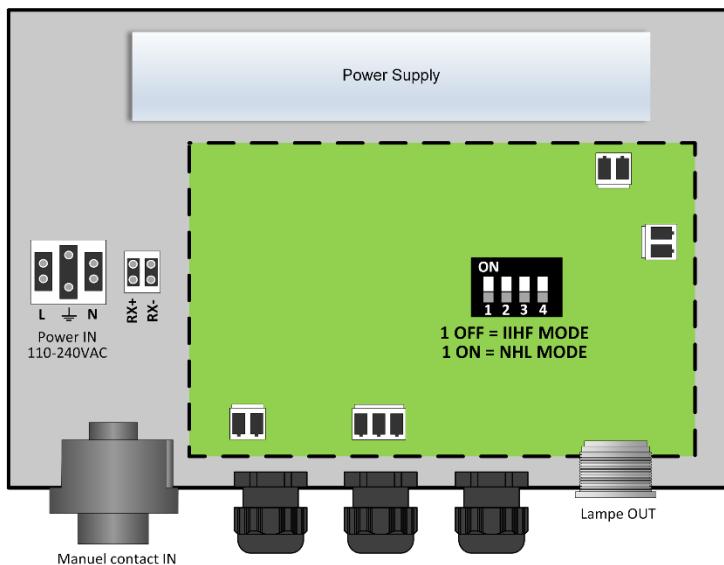

Dimensions / Dimensions / Grösse (mm):

240 x 210 x 110

Weight / Poids / Gewicht (kg):

1.2

Power / Puissance / Strom (VA):

130

2.5.2 Mounting / Montage / Montage

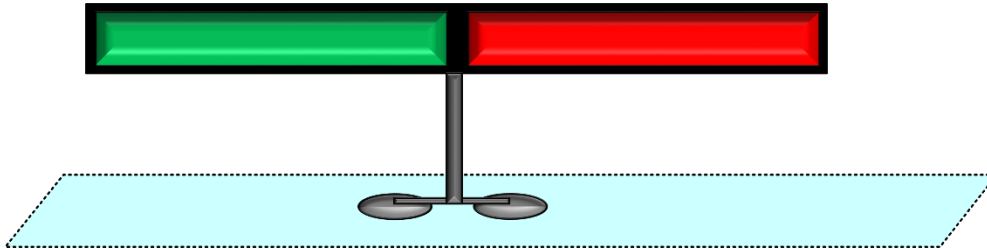

On flat surface in Plexiglas or glass with accessory 3500.014
Sur surface plate en Plexiglas ou verre avec accessoire 3500.014
Auf einer ebenen Oberfläche mit Glas oder Plexiglas mit Zubehör 3500.014

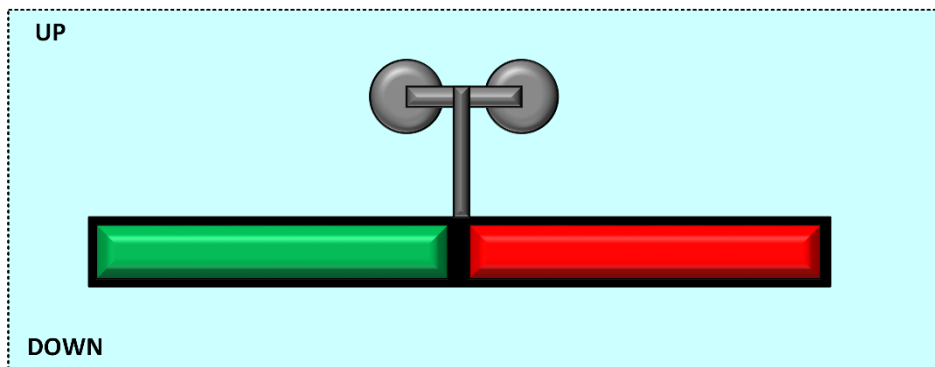

On vertical surface in Plexiglas or glass with accessory 3500.014
Sur surface verticale en Plexiglas ou verre avec accessoire 3500.014
Auf einer vertikalen Oberfläche mit Glas oder Plexiglas mit Zubehör 3500.014

2.5.3 Accessory 3500.014 / Accessoire 3500.014 / Zubehör 3500.014



2.6 External horn / Klaxon externe / Externe Hupe

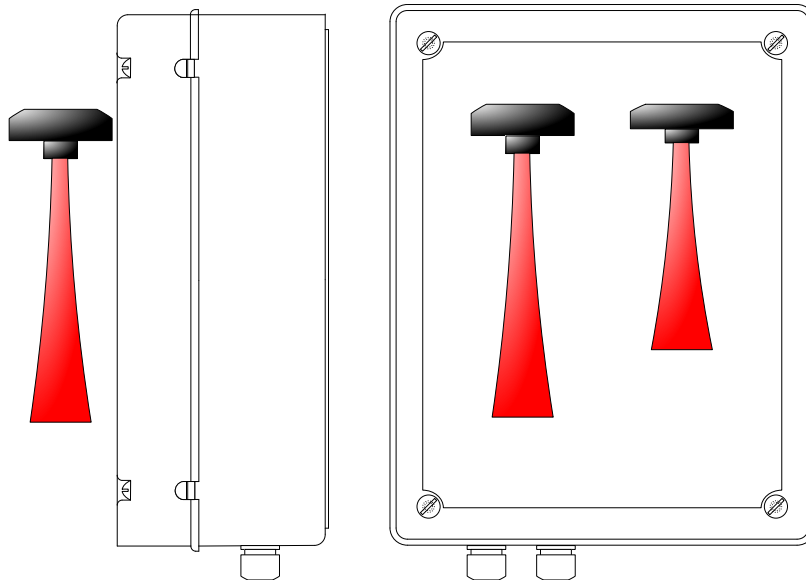

Dimension / Dimensions / Grösse (mm):	310 x 230 x 130
Weight / Poids / Gewicht (kg):	3.9
Power / Puissance / Strom (VA):	100

2.7 Saturn LCD Controller / Console LCD Saturn / Bedienungspult LCD Saturn



Dimensions / Dimensions / Grösse (mm):	285 x 210 x 84
Weight / Poids / Gewicht (kg):	1,5
Power / Puissance / Strom (VA):	30

3 ELECTRICAL INSTALLATION / INSTALLATION ELECTRIQUE / ELEKTRISCHE INSTALLATION

3.1 Main scoreboard / Tableau principal / Hauptanzeigetafel

3.1.1 Cabling / Câblage / Kabel

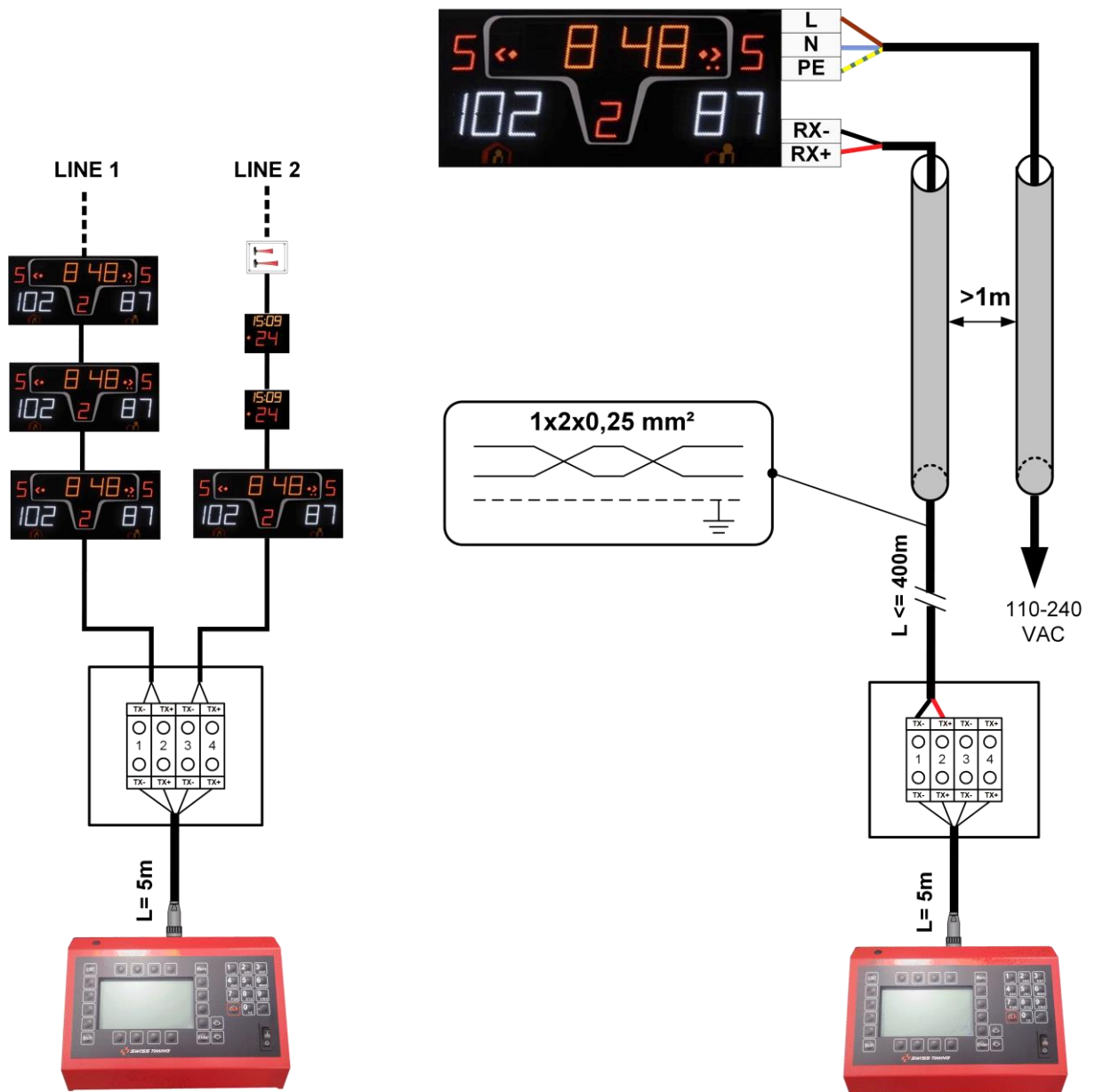

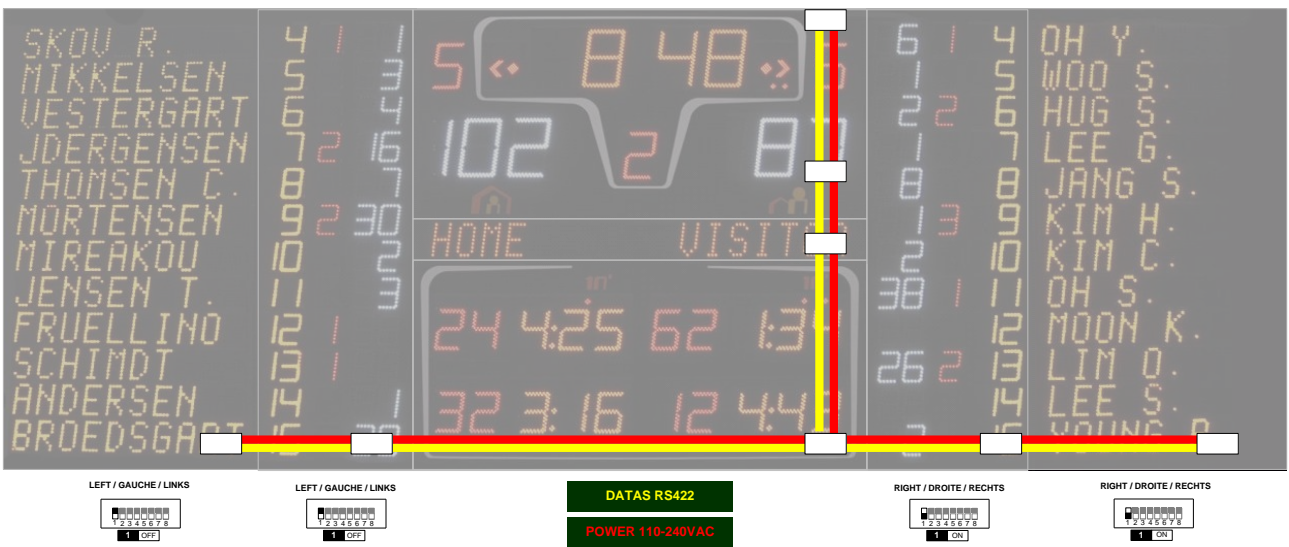
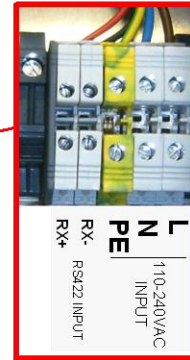
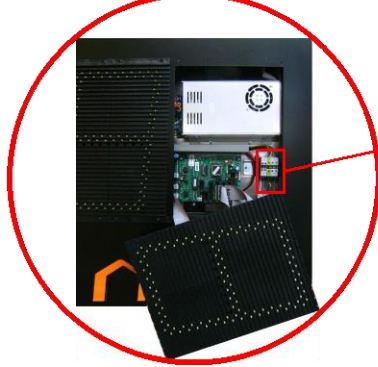

To controller / A la console / vom Scoreboard zum Bedienungspult:



Scoreboard internal / Interne tableau / Tafelanzeiger:

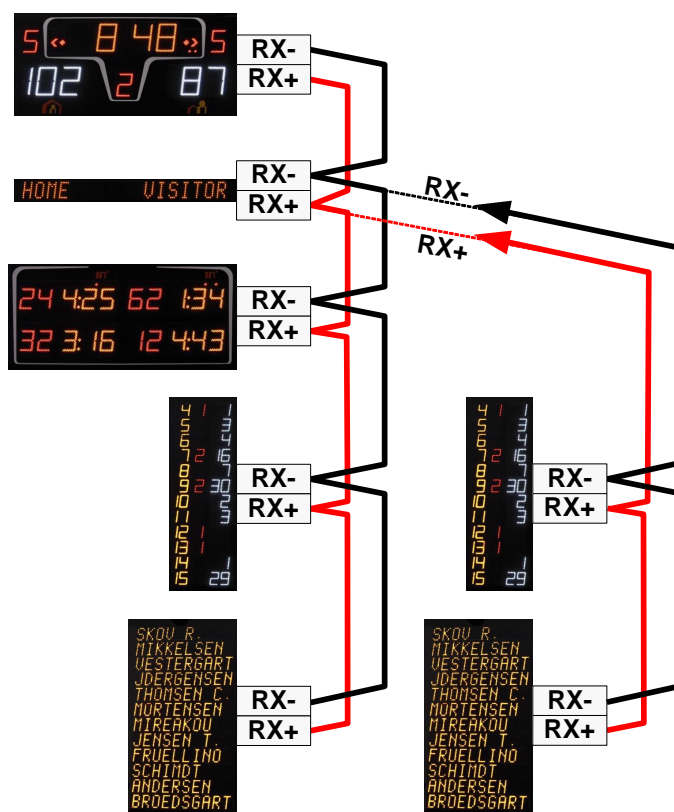

3.1.2 Switches setting / Sélection des switches/ Schalter und Einstellungen

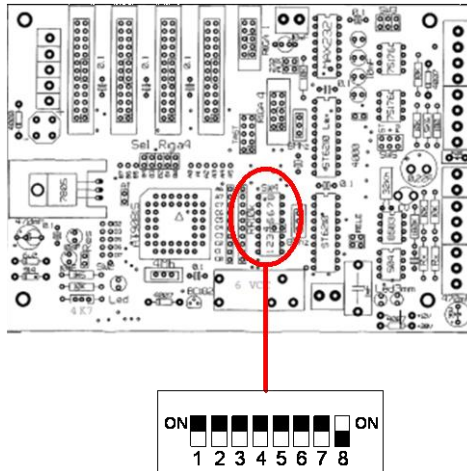

DIP switch	1		
	ON		Left module
		ON	Right module
2	-		-
3	-		-
4			RS422 input
	ON		Test

3.1.3 Brightness setting / Sélection luminosité / Wahl der Helligkeit

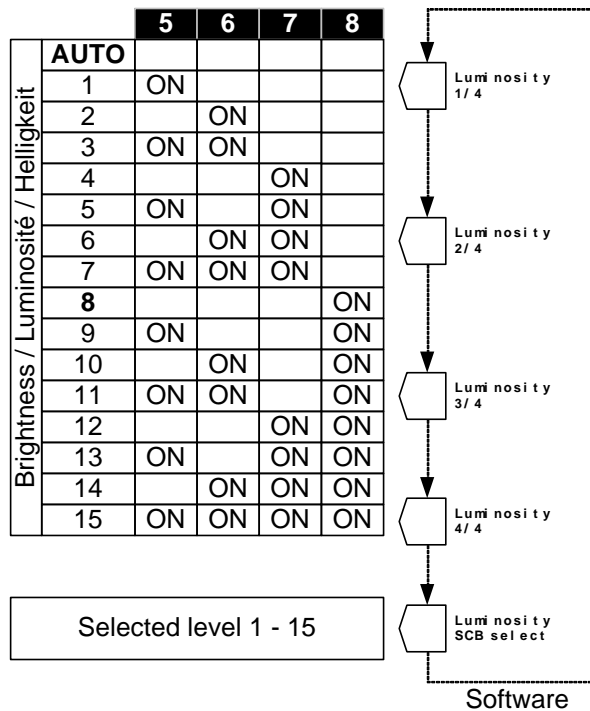

3.2 Shot clock / Shot clock / Shot clock

3.2.1 Single face / Simple face / Einseitig

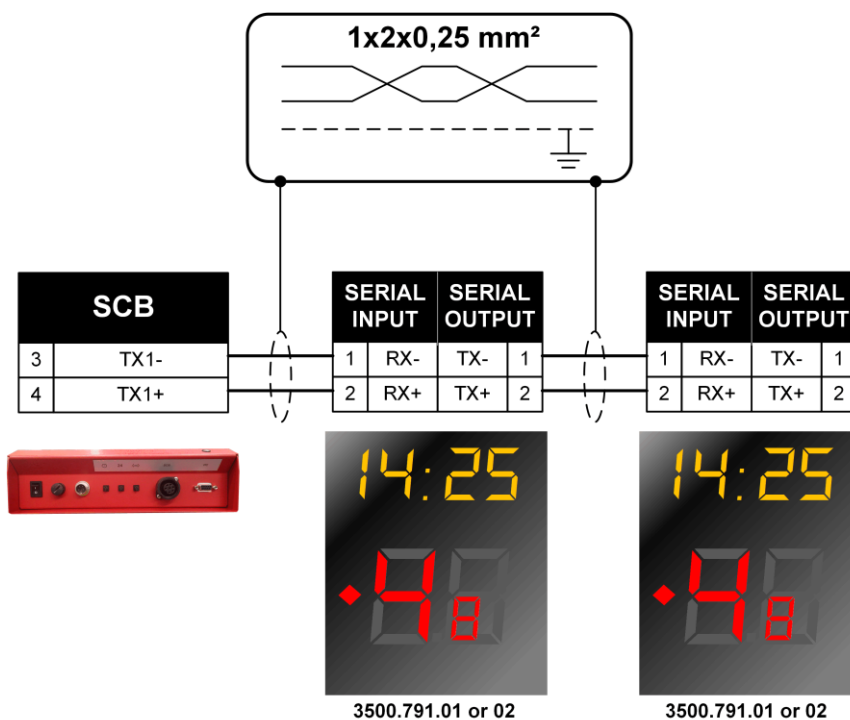
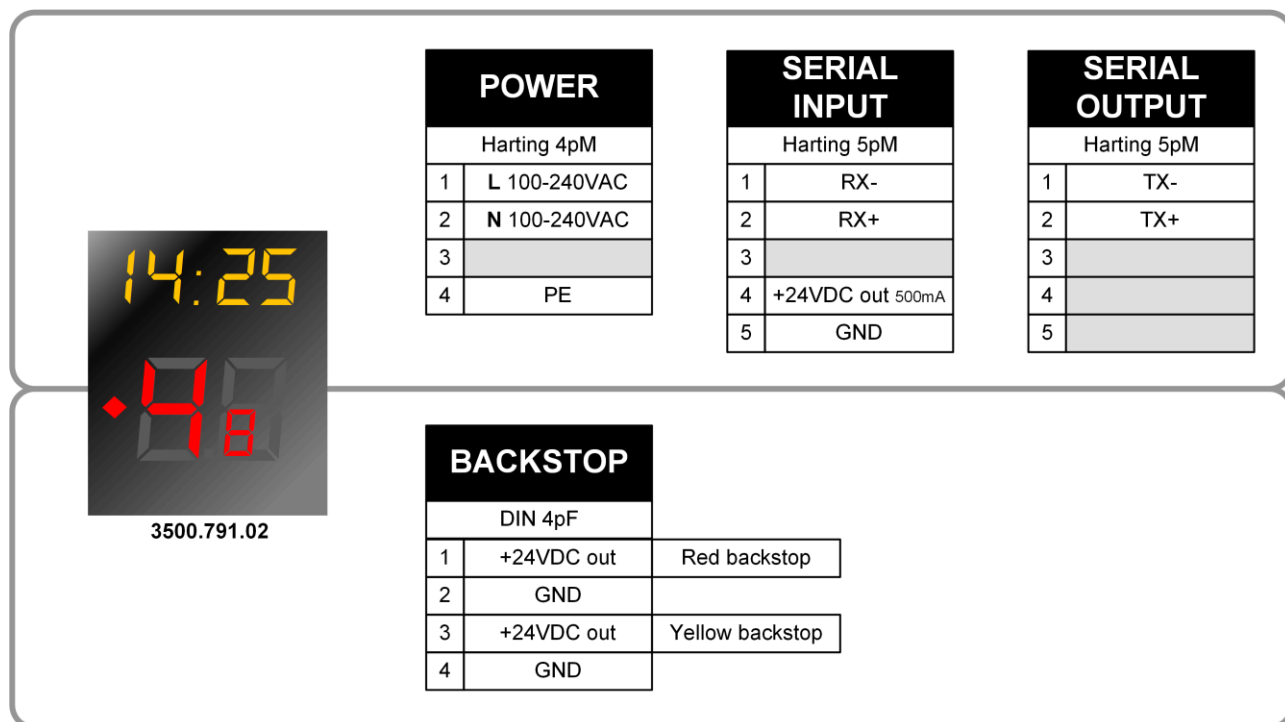

3.3 Possession 2.984



3.4 Total faults per team 2.985

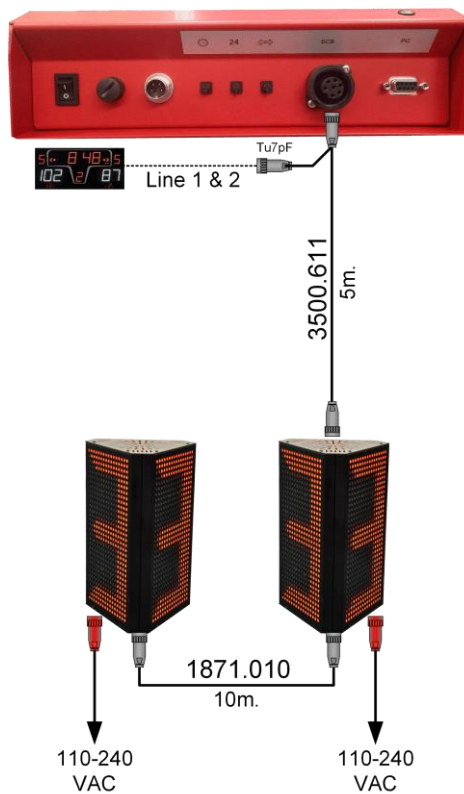

3.5 Backstop panel / Panneau Backstop / Anzeige Backstop

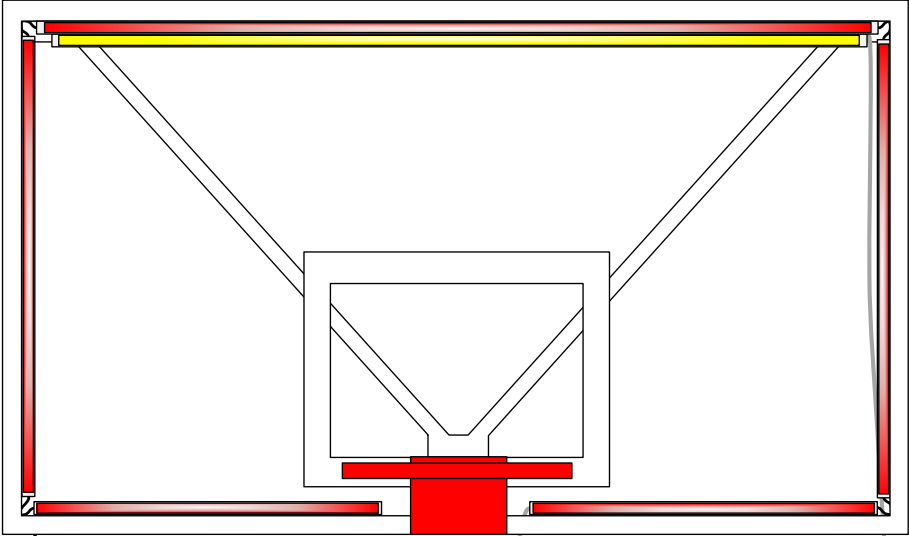

3510.661



3500.791.01 or 02

L= 1.5m

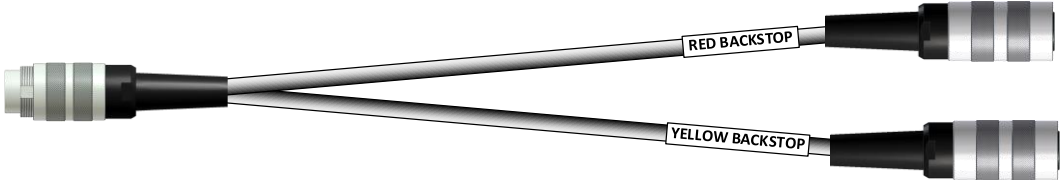

3510.935.01 / 3510.661

3.6 Goal lamps / Lampes de but / Torlampen

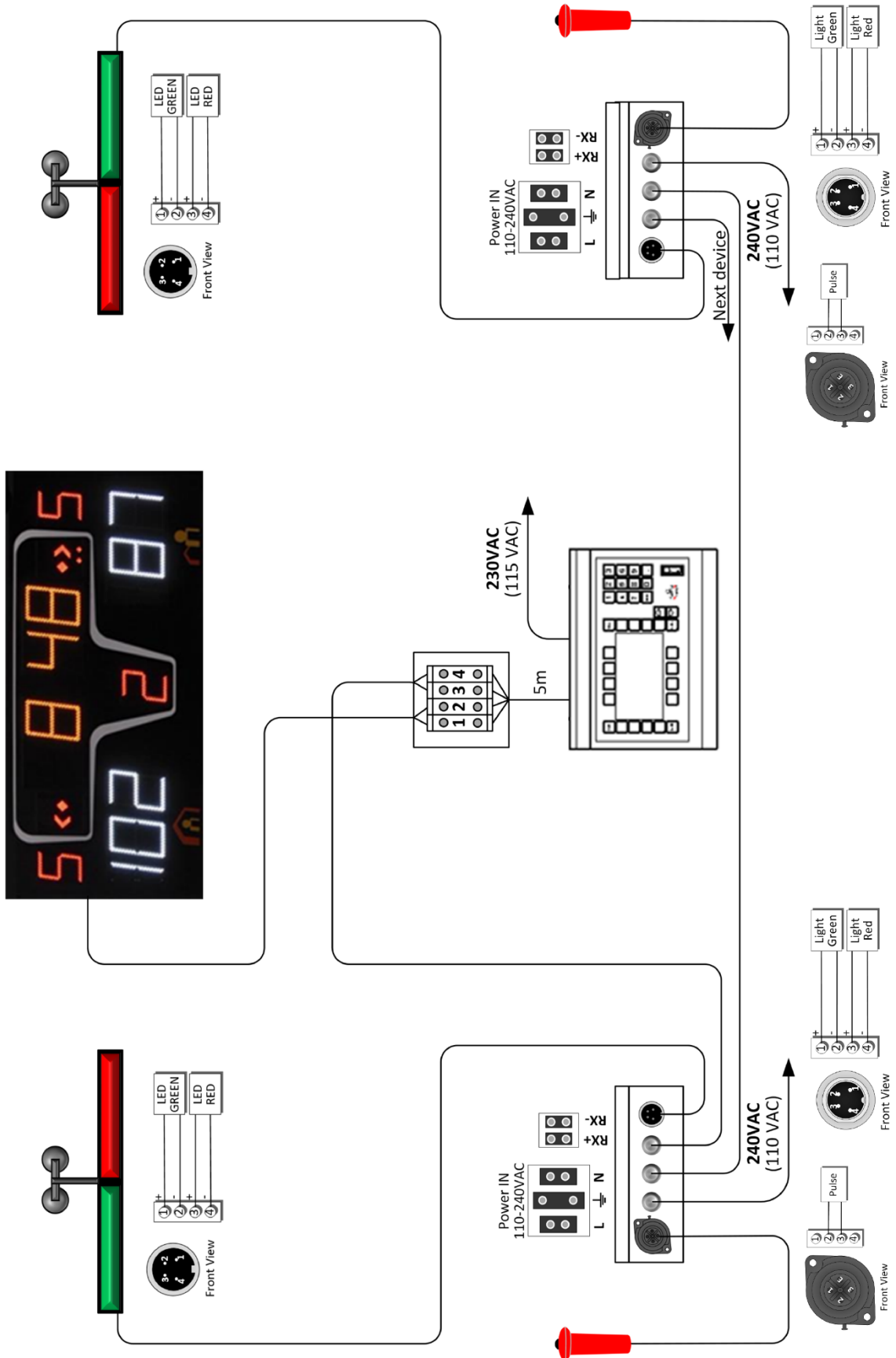

3.7 External horn / Klaxon externe / Externe Hupe

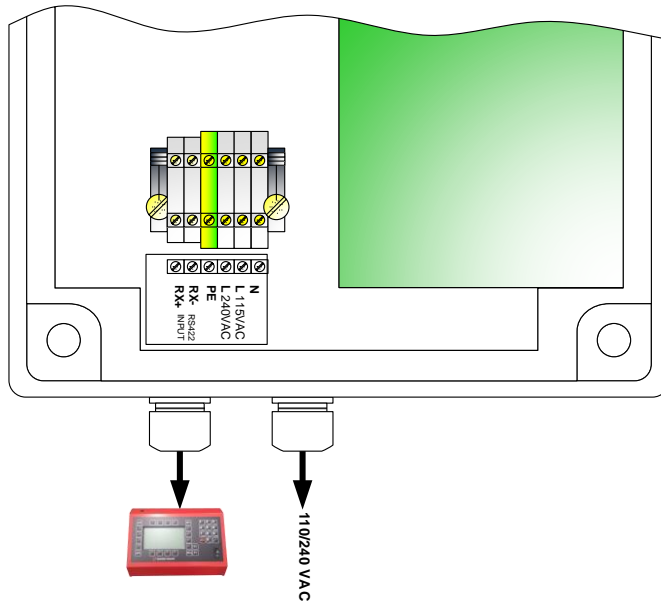
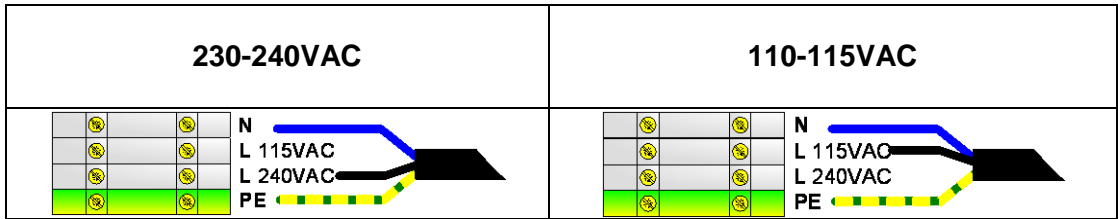

3.8 Controller / Console / Bedienungspult



9-18VDC	
DC Input	
DIN 4pMT	
1	+9-18V
2	GND
3	
4	

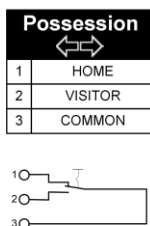
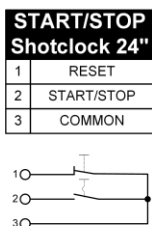

SCB	
RS422	
Tu 7pFT	
1	+12V
2	
3	TX1-
4	TX1+
5	TX2-
6	TX2+
7	GND

1	+12V
2	
3	TX-
4	TX+
5	RX-
6	RX+
7	GND

PC	
RS232	
Sub-D 9pFT	
1	
2	TXD
3	RXD
4	
5	GND
6	
7	
8	
9	

4 APPENDIX

4.1 Version history

Version	Modifications since last version
1.0	Initial version
1.1	Add backstop, new shotclock, mounting modifications (P.11/16)
1.2	Add dimensions on chapter 2.3.1 & 2.3.2
1.3	New Goal lamps chapter 2.5.1, 2.5.2 & 3.6
1.4	New Shotclock 1/10 & new backstop lights
1.5	Replacement screws for mounting floor standing

NOTES

